



CH24 | WISHBONE CHAIR - CLASSICS

HANS J. WEGNER | 1950





















The very first model Hans J. Wegner designed exclusively for Carl Hansen & Søn in 1949, the iconic CH24 Wishbone Chair has been in continuous production since 1950. More than 100 steps are required to manufacture each chair, most of which are carried out by hand. The hand-woven seat alone takes a skilled craftsman over one hour and 120 meters of paper cord to weave.





ICONIC · NATURAL MATERIALS · HAND-WOVEN SEAT · DURABLE · RESIDENTIAL · HOSPITALITY · WORKPLACE

FSC™ CERTIFIED 

VARIANTS AVAILABLE IN QUICKSHIP

-  Beech / Painted White
Natural paper cord 
-  Oak / Soap
Natural paper cord 
-  Oak / Oil
Natural paper cord 
-  Oak / White Oil
Natural paper cord 
-  Oak / Painted Black
Natural paper cord 
-  Walnut / Lacquer
Natural paper cord 
-  Mahogany / Oil
Natural paper cord 
-  Smoked / Oil
Natural paper cord 
-  Teak / Oil
Natural paper cord 

CU CH24 LOKE LEATHER CUSHIONS AVAILABLE IN QUICKSHIP

-  Loke 7050
-  Loke 7150
-  Loke 7160
-  Loke 7270
-  Loke 7748

PRODUCT DIMENSIONS

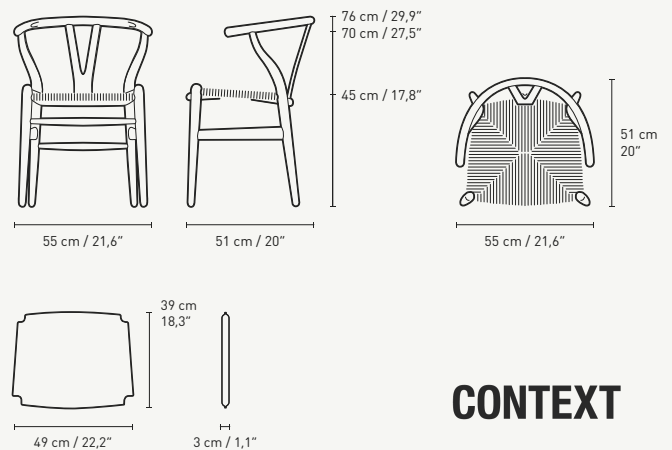

CONTEXT

ENQUIRIES
info@contextgallery.com
 Tel. 404. 477. 3301
 Tel. 800. 886.0867
contextgallery.com