



## Sail

Caronni + Bonanomi · 2013

A multi-version support for new-generation TV sets. Simplicity and lightness are the qualities of a technically elegant accessory that allows the moving image to play a leading role in the residential setting. Ideal for domestic use, yet also suitable for public spaces or workplaces.



## Available models

Tv-stand system for flat and curved screens. Swivelling steel frame. Integrated wiring box. Available in four versions: with base equipped of built-in monodirectional castors, with rear cable management, with rear wall-fixing system and with swivelling floor-ceiling upright.

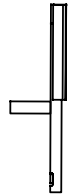
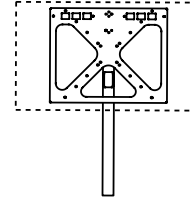
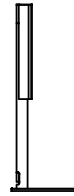
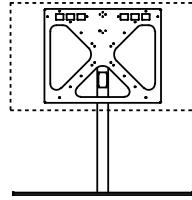
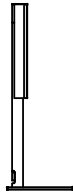
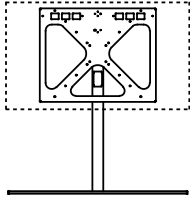

301 A01 /A02  
TV height 94 cm  
width 95 cm  
shelf depth 35 cm  
shelf height 26 cm

301 A03 /A04  
TV height 151 cm  
width 95 cm  
shelf depth 40 cm  
shelf height 73 cm

302 B01 /B02  
(cable management)  
TV height 94 cm  
width 115 cm  
shelf depth 40 cm  
shelf height 26 cm

302 B05 /B06  
TV height 94 cm  
width 190 cm  
shelf depth 40 cm

302 B07  
TV height 119 cm  
width 190 cm  
shelf depth 40 cm

304 C01 /C02  
TV height 94 cm  
width 54,5 cm  
shelf depth 30 cm  
shelf height 26 cm

304 C03 /C04  
TV height 119 cm  
width 54,5 cm  
shelf depth 30 cm  
shelf height 46 cm

304 C05 /C06  
TV height 151 cm  
width 54,5 cm  
shelf depth 30 cm  
shelf height 73 cm

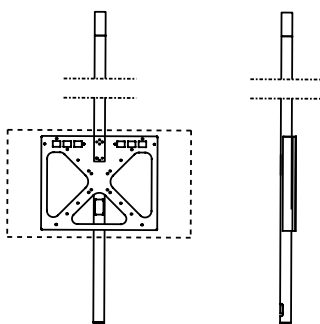

307 C01/C02  
TV height 94 cm  
width 54,5 cm  
shelf depth 30 cm  
shelf height 26 cm

307 C03/C04  
TV height 119 cm  
width 54,5 cm  
shelf depth 30 cm  
shelf height 46 cm

307 C05/C06  
TV height 151 cm  
width 54,5 cm  
shelf depth 30 cm  
shelf height 73 cm

## Finishing

### Struttura

#### Lacquers



A66  
LACCATO  
FERRO  
GREZZO



B59 NERO  
OPACO



B62  
BIANCO  
OPACO

